

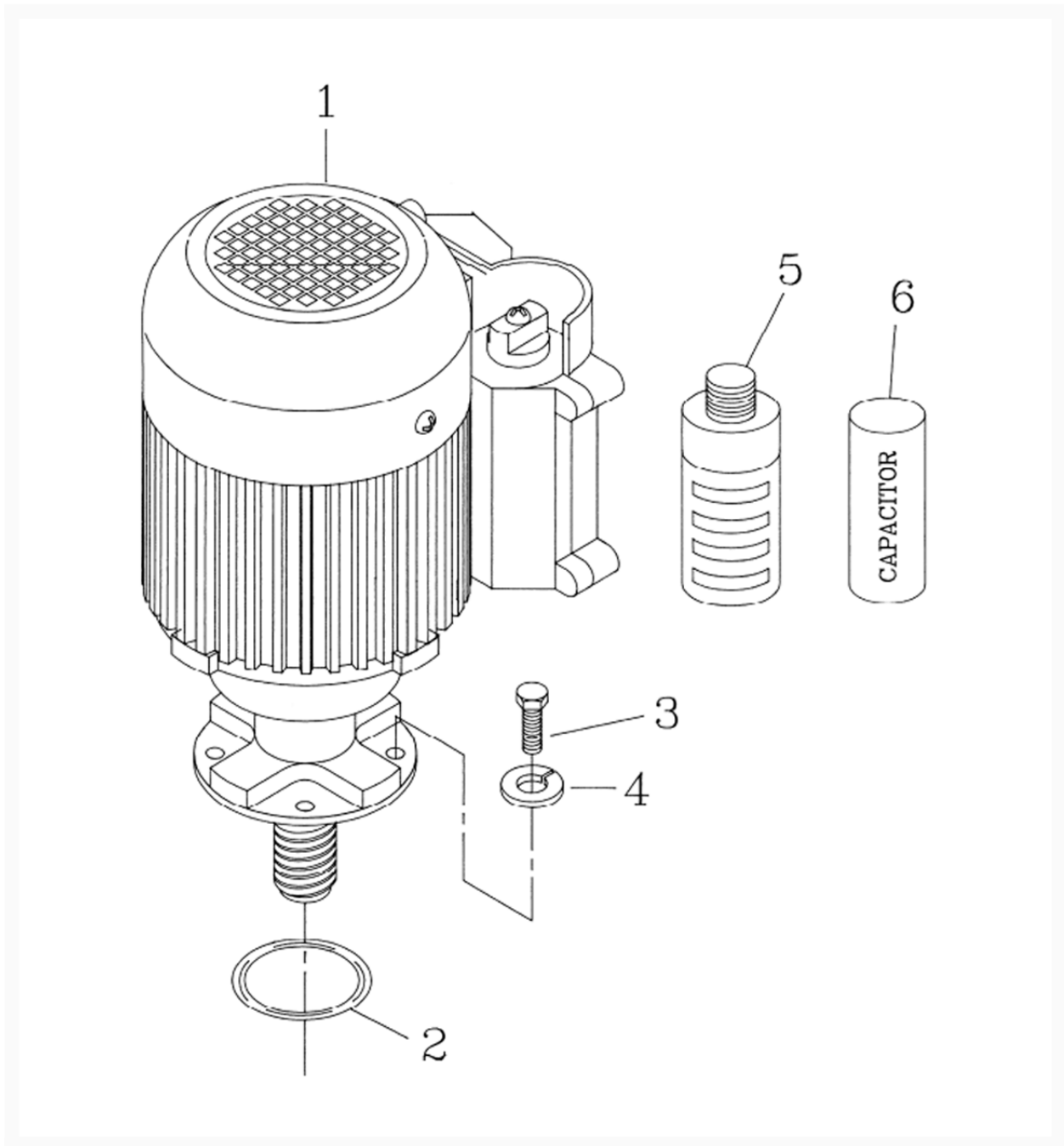

# PF-31 Motor Assembly

## Product Images

---



## Additional Information

---

Stock Number

1790807K-2

## Products in this set

---

