

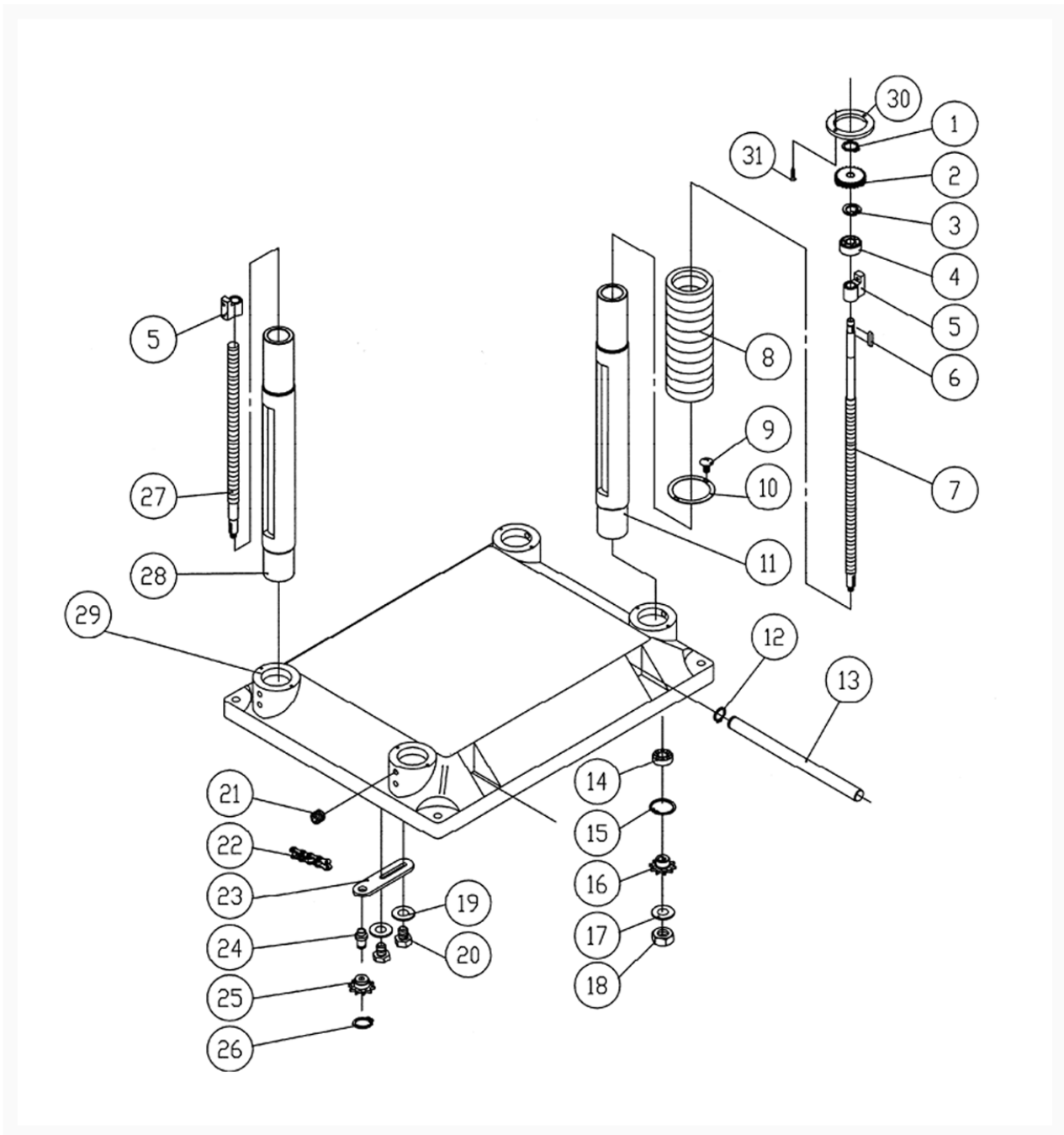

209HH 5HP 3PH Base Assembly

Product Images



Additional Information

Stock Number

1791316-2

Products in this set

